



# EAGLE® OWNER'S MANUAL

*A guide to caring for your EAGLE Windows & Doors.*

*Please take a minute to read the important information enclosed in this homeowner's manual. Failure to follow procedures will void warranty, written or implied.*

# Table of Contents

Introduction.....	3
Safety Considerations.....	3
Care and Handling.....	4
Finishing.....	5
Interior Finishing.....	5
Exterior Finishing.....	6
General Maintenance.....	7
Maintaining Exterior Finish.....	7
Cleaning Exterior Frame and Sash Members, Screens and Hardware.....	8
Care of Brass Hardware.....	9
Cleaning of Glass.....	9
Condensation.....	10
Sealant Inspections.....	10
Service Information.....	11
Casement and Awning Windows.....	12
Double-Hung Windows.....	16
Slide-By Windows.....	20
Circle Top and Geometric Windows.....	22
Patio and French Sliding Doors.....	23
Hinged French Doors.....	26
Entry Doors.....	33
Window Grilles.....	41
Window Blinds and Shades.....	43
Eagle 20/10 Limited Warranty.....	46

## Introduction

Congratulations and thank you for choosing EAGLE Window & Door products for your home. At EAGLE Window & Door, we take pride in producing quality, low-maintenance, energy efficient windows and doors that enhance and add beauty to your home. Because of our ongoing commitment to being a leader in service, quality and value, we are offering you this homeowner's manual to assist you in maintaining your windows and doors for years of continued enjoyment. "A guide to caring for your EAGLE Windows & Doors" includes complete instructions on finishing, cleaning, servicing and maintaining your windows and doors. Should you have any questions that have not been answered in this manual, please contact your local EAGLE Window & Door representative.

## Safety Considerations

### Safety Considerations and Warnings



*Remember to use the appropriate safety equipment.*

- Be familiar with your windows and doors and their operation. Don't attempt to install them alone. When installing your windows and doors or cleaning and removing sash, two or more people may be required, depending on the unit's location or weight. Be careful not to fall when working on ladders or scaffolding. Always think safety first!
- Do not leave openings unattended when small children are present. Falling from an opening may result in serious injury or death.
- Screens will not stop a child from falling out a window. They are designed only to keep insects out, not children in. Also, avoid placing furniture near or in front of windows to keep children from climbing onto window.
- If window blinds are utilized, keep cords out of the reach of children to avoid strangulation. The following devices may assist; clamp or clothes pin, cleat, tie-down device, or tying the cord to itself.
- Depending on procedure, wear the appropriate safety equipment (i.e. goggles, safety glasses, gloves, ear plugs, etc.).

- Never mix cleaners with cleaners. The mixing of cleaners may not only be ineffective, but also very dangerous. Always follow manufacturer's recommendations for diluting cleaners.
- Never use paint removers, alkaline, acid or abrasive cleaners. Always do a test in an inconspicuous spot before proceeding with cleaning.

## Care and Handling

### Care and Handling Prior to Installation

All windows and doors should be stored **upright** in a clean, dry surrounding prior to installation. Do not store flat or on edge. Protect unfinished windows and doors from dirt, water and abuse. Do not expose unfinished windows and doors to excessive moisture, heat, direct sunlight or extreme dry conditions. Always handle with clean hands.

*Warning: More than one person may be required for handling a unit depending on size, weight and/or job site conditions. Use the appropriate amount of people when handling your windows and doors. Failure to do so could result in injury.*

Finish and install your windows and doors as soon as possible. Remember to stabilize the moisture content of your building interior and allow windows to adjust to surrounding conditions. All wood surfaces require finishing or painting. It is very important that your windows are finished immediately. We recommend you finish all exposed wood surfaces prior to, or immediately after, installation. This will ensure proper operation and long-term quality performance. Failure to do so will void any warranty, written or implied.

If additional instructions are needed for installation, please contact your EAGLE Window & Door representative.



*Windows and doors should be stored in an upright position.*

# Finishing



## Interior Finishing for Windows and Doors

### Preparatory Steps

1. Fill any visible nail holes in the glazing and sash stops with a quality wood filler.
2. Make sure your work area is well ventilated before sanding and finishing. Poor ventilation could cause nausea or injury.
3. Sand all interior wood surfaces lightly with 180 grit sandpaper to remove any handling marks, etc. Do not use orbital or belt sanders. Hand sanding with a sanding block is sufficient and ensures a consistent finish. Always sand in the same direction of the wood grain. Be careful not to scratch the surface of the glass while sanding.
4. Wipe all surfaces clean of dust with a clean tack cloth or a soft light rag. Do not use cleaners (i.e. furniture polish, etc.).
5. It is highly recommended that all finish materials are from the same manufacturer. This will ensure compatibility of all coatings.
6. As a reminder, be sure to finish all exposed wood surfaces of your windows and doors and all of the edges (including top and bottom).
7. To prevent magnification of blemishes, avoid using dark stains on light colored wood surfaces and entry door lite surrounds.
8. Make a test patch in an inconspicuous area prior to staining the entire surface to check the desired results.
9. Do not paint or stain any of the weather-strips, jamb liners, screens or hardware! *This will void the warranty!*



Use high-quality finishes for best results.

### Recommended Steps for Staining

1. A sanding sealer applied prior to staining may deliver improved staining consistency. However, it is not required.
2. Apply stain to all wood surfaces, following the manufacturer's instructions.
3. Allow stain to dry. Then apply a high-grade, polyurethane, clear top coat over the stain, again

- following the manufacturer's instructions.
4. When dry, lightly sand with 220 grit sandpaper. Wipe clean with a clean tack cloth to remove dust.
  5. Apply second coat of clear top coat and lap finish  $\frac{1}{16}$ " onto the glass. This will minimize the amount of moisture that can penetrate between the wood glass stop and the insulating glass.
  6. If a third coat is desired, repeat steps 3 and 4.
  7. Do not close window or door until the finish is thoroughly dry as per manufacturer's recommendations.

### **Recommended Steps for Painting**

1. Apply one coat of a quality primer to all wood surfaces, following the manufacturer's instructions.
2. Allow primer to dry. Then apply two coats of a quality paint and lap finish  $\frac{1}{16}$ " onto the glass. This will minimize the amount of moisture that can penetrate between the wood glass stop and the insulating glass.
3. Do not close window or door until the finish is thoroughly dry as per manufacturer's recommendations.

### **Recommended Steps for a Natural Finish**

1. Apply a high-grade, polyurethane, clear top coat following manufacturer's instructions.
2. When dry, lightly sand with 220 grit sandpaper. Wipe clean with a clean tack cloth to remove dust.
3. Apply a second coat of clear top coat and lap finish  $\frac{1}{16}$ " onto glass. This will minimize the amount of moisture that can penetrate between the wood glass stop and the insulating glass.
4. If a third coat is desired, repeat steps 2 and 3.
5. Do not close window or door until the finish is thoroughly dry as per manufacturer's recommendations.

### **Exterior Finishing of Primed All-Wood Windows and Doors**

*Note: The following steps are for all-wood windows and doors only. Aluminum clad windows and doors already have an exterior finish.*

## Preparatory Steps

1. Wipe all surfaces clean of dust with a clean tack cloth or a soft light rag. Do not use cleaners (i.e. furniture polish, etc.).
2. Make sure your work area is well ventilated before sanding and finishing. Poor ventilation could cause nausea or injury.
3. It is highly recommended that all finish materials are from the same manufacturer. This will ensure compatibility of all coatings.
4. As a reminder, be sure to finish all exposed wood surfaces of your windows and doors and all of the edges (including top and bottom).
5. Make a test patch in an inconspicuous area prior to painting the entire surface to check the desired results.
6. Do not paint any of the weather-strips, jamb liners, screens or hardware! *This will void the warranty!*

## Recommended Steps for Painting

1. Apply two coats of a high-quality top coat oil or water-based paint, again following the manufacturer's instructions. Lap the finish coat  $\frac{1}{16}$ " onto the glass. This will minimize the amount of moisture that can penetrate between the wood glazing stop and the insulating glass.
2. Paint with sash either removed or open. Do not close until paint is thoroughly dry as per manufacturer's recommendations.



Use touch-up paint sparingly to cover small nicks or scratches.



Cleaning with alcohol.

## General Maintenance

### Maintaining Exterior Finish

The exterior finish on aluminum clad windows and doors is a durable high-solid polyester finish which effectively shields the exterior from outside elements. Do not paint over these finishes! However, for small scratches or nicks, a small bottle of EAGLE touch-up paint is available. To prepare the area, lightly sand with a very fine sandpaper. Clean the area thoroughly with mineral spirits, let dry and paint. Scuffs, excess caulking and other minor blemishes usually can be removed by using denatured

alcohol and a soft cloth. To aid in prolonging the life of the exterior finish on your aluminum clad windows and doors, a high-quality automotive wax has proven to be advantageous. Follow wax manufacturer's instructions for applying. The exterior finish on primed all-wood windows and doors should be carefully inspected at least twice a year in order to retain its protective finish. If the window or door has been painted a dark color, or is directly exposed to sunlight, inspect more frequently. Refinish as often as necessary to preserve the protective quality of the finish. To repair small dents in the exterior finish where the grain is not broken, apply water to the area. Let set and grain will raise by itself. Where grain is broken, clean area, fill with wood filler and refinish.

### **Cleaning Exterior Frame and Sash Members, Screens and Hardware**

To clean the exterior frame and sash member of clad windows and doors, use a soft cloth dampened with a mixture of mild soap and water. Do not use any abrasive cleaners or scraping tools that may damage the finish. A soft cloth, brush or sponge works best for cleaning. Always restrict cleaning to mild weather or on a shaded side of a building. For stubborn dirt or grime, use a mild solvent such as mineral spirits or a solution of water and denatured alcohol. Always rinse surface with clean water when finished. Clean the exterior sill area under the window sash frequently to prevent dirt and debris from interfering with the window's performance. Acid solutions used to wash brick can damage the finish, glass and hardware. Take extra precaution by covering entire surface of window or door with plastic during masonry construction stages. If acid solutions do come in contact with unit, rinse glass and hardware with clean water immediately after exposure to avoid damage.

To clean the exterior frame and sash members of all-wood windows and doors, follow the paint manufacturer's instructions for cleaning.

In sea coast and/or heavy industrialized areas, clean

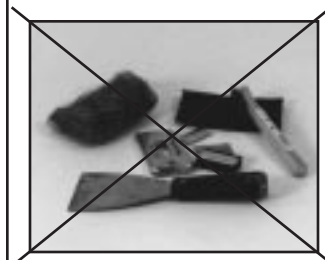

*Do not use abrasive cleaners and tools.*



*Soft brushes and sponges work the best for cleaning.*



*Removing dust with a vacuum cleaner brush.*



*Maintaining brass finishes.*



*Commercial glass cleaners.*

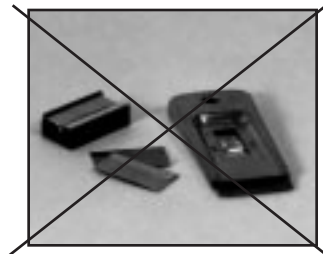

*Do not use razor blades*

your glass, hardware and screens often to remove any chemicals or mineral deposits that may have collected. After cleaning, lubricate the moving parts of the hardware with a dry silicone spray. Do not use heavy oil lubricants that may collect corrosive particles. Hose down or dust off your insect screens occasionally to restore them to their original appearance. A soft fiber brush with soap and water or a vacuum brush may aid in cleaning.

### **Care of Brass Hardware**

A protective lacquer coating on EAGLE's brass hardware maintains the brilliant finish for years. Eventually, brass hardware, whether applied in exterior or interior applications, will show signs of wear or tarnishing. The rate at which tarnishing may occur depends on the surrounding environmental conditions. High industrialized or coastal areas generally accelerate the levels of tarnishing.

Routine maintenance of the hardware with a mild soap and soft rag may prolong the life of your brass hardware. Do not use abrasive cleaners as they may scratch the coating. If tarnishing of the hardware reaches an undesirable level, the components should then be refinished. First, remove all brass hardware from the window. Then remove remaining lacquer with a very fine (No. 0000) steel wool soaked in a solution of soap and water. This will keep metal abrasion to a minimum. For tough to clean hardware, soak in lacquer thinner overnight. Once the tarnish is removed, you can restore the hardware's luster with any commercial polish. Then a quality automobile wax will help maintain the finish. Do not try to reapply a lacquer finish unless the proper tools and experience are available.

### **Cleaning Glass**

Glass may be cleaned with a variety of mild cleaning solvents. Generally, water with a mixture of vinegar works best. Other commercial products like Windex® or Fantastic® are sufficient. Note: Do not use razor blades as the glass might scratch. To remove sealants or grease and oil on the glass, use denatured alcohol or mineral spirits sparingly. Then follow-up by cleaning with a water/vinegar mixture. If cleaner

residue has come in contact with painted surfaces, weather strip or hardware, clean immediately with a damp cloth. *Note: Never apply films to the glass for added light control. Doing so will void glass warranty.*

### **Condensation**

Persistent condensation problems on windows, mold on ceilings or walls, and musty odors are all signs of moisture related-problems in the home. These problems are not only annoying, but can cause extensive damage to your home and windows if not remedied. To protect your home from moisture, you must first recognize the nature of the problems and understand their cause. Condensation is the visible result of excess humidity. Warm air holds more moisture than cool air; but when warm air meets a cool surface, it cools and can't hold as much moisture. That excess moisture changes to water and becomes visible as condensation.

Condensation is produced by moisture in the air; it is not produced by the window. For more information regarding condensation, why it occurs and possible solutions for elimination, please contact your EAGLE dealer and ask for "A Complete Guide To Understanding Condensation" brochure, or talk to your local heating and cooling specialist.

### **Sealant Inspections**

On a yearly basis, check to make sure that the sealant between the window/door frame and exterior siding is in tact. Cracks, chips or dried-out sealant may allow wind and water to penetrate into the walls. If the condition of the sealant has deteriorated, remove and apply a fresh, quality sealant around the perimeter of the window or door.

Check the sealant between the exterior of the sash and the glass. If the sealant is below the sash metal, an additional bead of a quality silicone may be applied to deter the outdoor elements.

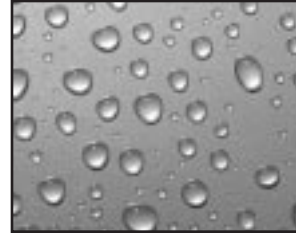

*Condensation*

Also, check the exterior sash and frame miters to make sure they are properly sealed. If additional sealant is necessary, apply sparingly and wipe excess off with a damp cloth.

Maintaining these sealants will extend the life of your windows and doors and will improve overall performance.

## Service Information



*Removing Shipping Blocks*

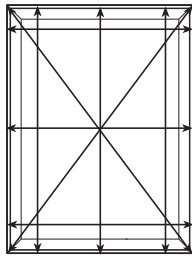

*Check horizontal, vertical and diagonal measurements.*

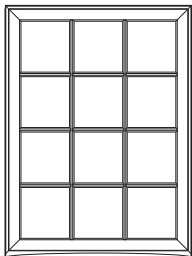

*Is the sill crowned?*

To maintain its recognition as a leader in the window and door industry for service, quality and value, EAGLE places great importance on the overall quality of their products. Each window is inspected for quality appearance and operation prior to shipping. With this in mind, if you experience a problem with your window, first check the troubleshooting sections on the following pages. If you think a service call is still required, we suggest that proper installation is checked first. Generally, most service calls are related in part to the initial installation of the window. To assist in detecting problems, please follow the suggested steps before making a service call:

- Make sure the shipping blocks are removed under the sash on casement windows.
- Check the unit for level, plumb and square.
- Make sure the weather-stripping and hardware has not been stained, varnished or painted.
- Inspect the exterior sealant between the window and the building/siding. Sealant should be consistent in application and should not be cracked or chipped.
- Check that side jambs have not been over-shimmed or over-stuffed with insulation.
- Side jambs also may require additional shimming.

Should there be any questions regarding service-related problems after this inspection, please read the following EAGLE Limited Warranty for instructions on pg. 46.



## Casement and Awning Windows

### Operation

To open the window, lift up the sash lock lever(s) to unlock. Rotate the crank handle to pivot the sash outward. *Note:* To open a casement window, always rotate the crank handle up and over toward the side of the window with the sash locks. Rotating the opposite direction with the window closed could cause damage to the operating mechanism. To open awning windows, rotate the crank handle counter clockwise. Always remember to unlock the window before you try to open it. To close the window, simply reverse the above steps. Always lock the sash locks when the window is not in use. This will prevent sash warpage and maintain a consistent seal around its perimeter.

### Cleaning the Glass

The hardware on EAGLE Casement windows allows you to wash the exterior of the glass from the inside. Simply crank the sash fully open, and reach between the frame and the sash. *Note:* Casement windows with special egress hardware require washing from the exterior. Awning windows are designed to open 45 degrees or



*Lifting the sash lock lever.*



*Cleaning exterior glass from the inside.*

less. To clean the glass on the exterior, unhook the operator arm from the sash bracket. The sash can then be pushed upward to a 90 degree angle and you can reach through to clean the exterior of the glass.

*Caution: With the sash unattached from the operator arm, be sure not to inadvertently let go of the sash. The sash could close abruptly or be caught by the wind, causing damage or injury.* If windows are to be cleaned from the exterior, take the necessary precautions not to fall from the opening. For recommended cleaning solutions, see page 9.

## Screen Removal

To remove insect screen, push up on the top screen frame rail and pull out on the screen tab at the bottom rail of the aluminum screen frame. Reverse this procedure for reinstalling.



Removing the screen.



Cleaning the tracks.



Removing the crank handle.



Removing the sash weather-strip.

## General Maintenance

To keep your casement and awning windows operating smoothly, keep the hinge tracks free of dirt and debris. A small brush may aid in cleaning the tracks.

To remove the crank handle on your window, just pull off. Some older models may have a set screw located at the bottom of the handle which requires loosening first.

To replace bulb weather-strip on the sash, gently pull on the end of the old weather-strip and remove from the kerf in the window sash. If the new weather-strip has been supplied pre-cut and mitered, then match the weather-strip to the correct side, and push the flange of the weather-strip into the kerf starting at one end of the sash. Next, gently tap down the weather-strip with a hammer to fully set the weather-strip into the kerf. Follow this same procedure for the remaining sides. Do not apply bulb weather-strip to the bottom rail of the sash. If weather-strip has not been trimmed to size, cut the weather-strip with a 45 degree angle on both ends to fit the top of the sash. Push the flange of the weather-strip into the kerf starting at one end of the sash. Gently, tap the weather-strip in across the top of the sash. Next,

cut a 45 degree angle and apply weather-strip to the sides of the sash starting from the top and working to the bottom. Cut the weather-strip off at a 90 degree angle on the bottom of each side piece. Do not apply weather-strip to bottom rail of the sash.

To remove a casement sash, crank sash open until the operator arm is located in the middle of the track on the sash. Gently push the operator arm downward to remove from track. Crank the operator arm back under the sill cover. Next, using a slotted screwdriver, release the stud clip at the end of the operator arm that attaches to the operator bracket. Remove the hinge arm from the hinge track stud at the top and then the bottom. Hold sash firmly while prying the hinge arm off the stud with your screwdriver. When hinges are removed, continue to hold sash firmly, and slide the entire sash to the end of the track towards the lock side, and remove from the opening.

To remove an awning sash, crank the sash open about 6 inches, and detach the operator arm from the sash bracket on the sash. Then crank the operator back underneath the sill cover. Next, while firmly holding onto the sash, use a slotted screwdriver to release the stud clips on the hinge arms. Remove the hinge arm from the stud clips on both sides and carefully lower the sash until the hinges slide out of the hinge track.

*Caution: When removing sash, two or more people may be required depending on the window location or sash weight. Please use extreme caution! When sash is removed, do not leave opening unattended.*

## Troubleshooting

### Sash does not open

If the sash does not open, check to make sure the sash locks have been completely disengaged. Rotate the crank handle and lightly push against the sash near the locks until the sash opens. If the sash is sticking to the weather-strip, apply a thin layer of paraffin to the bulb weather-strip and to the outer edge of the sash.



*Pushing the operator arm downward and removing from track.*



*Releasing casement operator stud clip.*



*Releasing stud clip on hinge arm.*



*Removing sash - slide sash to end of hinge track.*



*Detaching awning operator arm from sash.*



*Releasing stud clip on awning hinge arm.*



*Applying paraffin wax.*



*Removing the shipping block.*



*Making sure the frame is square.*

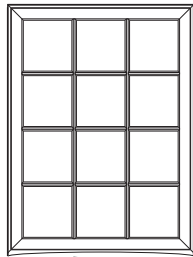

*Is the sill crowned?*

### **Sash does not operate smoothly**

If the sash is not operating smoothly, first check to see if the hinge tracks on top and bottom of frame are clean. Dirt and debris in the track may affect the operation. If dirty, clean with soapy water and a brush. Then apply a dry silicone spray to the hardware for additional lubrication.

### **Sash drags on sill when opening and closing**

If the sash drags on the sill, first make sure the shipping blocks with orange tags were removed from the bottom and top of sash. Secondly, make sure all sash parts have been sealed and finished. Has the unit been installed correctly? Is the frame square? Is the sill crowned? If drag still remains a problem, contact your EAGLE representative for assistance.

### **Crank handle comes off**

If a set screw is located on the base of the handle, make sure it is tight at all times. Newer models have a friction fit and should not come loose.

Should there be any questions regarding service-related problems after this inspection, please read the Service Information at the beginning of this guide for additional instructions.

Note: Do not remove the window sash to clean the glass! For recommended cleaning solutions, see page 9.



## Double-Hung Windows

### Operation

To open the window, unlock the sash lock(s) by turning the lever(s) to the right. *Note: Make sure lock is turned completely open to avoid damage to the lock and window.* You may then open either the bottom or top sash. To close the window, reverse these steps. Always lock the sash locks. Locking the window not only keeps the window secure, but holds the sash firmly against the weather-strip to create a tight seal.

To tilt sash, see the following glass cleaning steps.

### Cleaning the Glass

EAGLE Double-Hung Windows feature a tiltable upper and lower sash for cleaning made simple from the inside. To tilt lower sash, unlock the sash lock(s), and raise the lower sash about 3". Grip the top left of the lower sash while depressing the left vinyl jamb liner above the corner of the sash. Pull forward from the top until the sash pulls away from the jamb liner about one inch. Repeat this step on the right side until the whole sash tilts forward. *Caution: Do not release the sash unless it is resting on a padded surface, and do not tilt past 90°. Doing so could damage the*



Unlocking the sash.



Raising the sash.



Pulling sash away from the jamb liner.



Cleaning the glass.



Lifting butterfly catch on screen.



Proper seating of screen at head.



Lubricating the jamb liner with paraffin.

jamb liners. *Note: The upper sash will not tilt inward until the bottom sash has been tilted in.* Next, pull the upper sash down about 3" from the top. *Caution: Lowering this sash more may cause over-extension and undue stress on the balance system. Note: Some units may have fixed upper sash that do not operate. Large units may have lower sash with limited travel upward. Never try to raise or lower a sash when it is in the tilted position.* Again, grip the top of the sash and tilt out following the same steps as the lower sash. After washing the upper sash, grip the top of the sash and tilt upright to the original position. Press firmly until sash engages back into the jamb liner. Slide upper sash completely up. Next, after washing the lower sash, tilt the sash upright and snap firmly back into the jamb liner. Slide lower sash down and lock window. *Note: Do not remove the window sash to clean the glass!* For recommended cleaning solutions, see page 9.

## Full Screen Removal

To remove insect screen, first raise the lower sash of the double-hung window to its highest position. Then, lift the butterfly catch located on both sides of the window. Push the screen toward the exterior to clear the sill, and pull downward. Turn the screen and carefully pull inside. To reinstall the screen, reverse the procedure. Always make sure the top of the screen is properly seated in the head jamb of the window and the catches lock the screen to the frame. *Note: Some units may have half screens rather than full screens.*

## General Maintenance

To help keep your double-hung windows operating smoothly, be sure to keep the jamb liners clean. A mild soapy detergent or denatured alcohol is sufficient for cleaning the vinyl surface. Do not use abrasive cleaners, as they may scratch the vinyl surface. Lubricate the jamb liners with a thin coat of paraffin or a dry silicone spray if needed. Be careful not to over-lubricate and cause the sash to drift. Apply a little lubricant and experiment.

To remove the double-hung lower and upper sash, the procedure is comparable to cleaning the glass with a few additional steps. First, raise the lower sash about 3". Grip the top left of the lower sash while depressing the left vinyl jamb liner above the corner of the sash. Pull forward from the top until the sash pulls away from the jamb liner. *Note: For added convenience, a jamb spreader tool is available from your EAGLE window dealer.* Repeat this step on the right side until the whole sash tilts inward. *Caution: Continue to firmly hold on to the sash at this stage.* Next, lift one side of the sash straight up until it disengages from the terminal. Then lift the opposite side and carefully pull the sash inside. To remove the upper sash, pull the sash down about 3". Again, grip the top of the sash and tilt following the same steps as the lower sash. To replace the sash, reverse the procedure while making sure the metal pivots on the sash are fully seated in the metal locking terminal of the sash shoe. Then tilt sash upward and press into jamb liners. *Note: When replacing sash, the upper sash must first be replaced and slid into place before the lower sash. Do not remove the window sash to clean the glass!*

To remove vinyl jamb liner, first remove both sash following the procedure listed above. Then grip the bottom inside and outside edge of the jamb liner and compress until the outside edge pops out first. Gradually pop the outside edge out all the way to the top. Then, at the bottom, gently pull jamb liner away from the inside edge while slowly pulling the bottom edge across the sill toward the opposite side. The jamb liner will then become free from the head of the window and can be removed. *Caution: Do not turn the sash shoe locking terminals on the jamb liner unless the sash is attached. Doing so could result in injury!*

## Troubleshooting

### Sash does not open

If the sash does not open, check to make sure sash locks have been completely disengaged.



*Removing the sash.*



*Compressing and disengaging jamb liner from frame.*



*Slowly pull the bottom edge of jamb liner across sill and remove.*



*Making sure the frame is square. Check horizontal, vertical and diagonal measurements.*

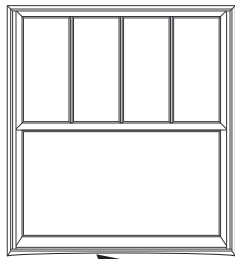

*Is the sill crowned?*



*Adjusting the tension of sash shoe.*

**SASH SHOE  
ADJUSTMENT SCREW**

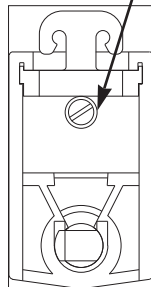

*Double-hung sash shoe.*

## **Sash is hard to operate**

If the sash is operating hard, check to make sure the jamb liner is clean of dirt and debris. A thin coat of paraffin or a dry silicone spray may be helpful for lubricating the vinyl jamb liner. Check to make sure window trim nails haven't punctured through the jamb liner. Also, check to make sure the sash is seated correctly in the metal locking terminal of the sash shoe inside the jamb liner, especially after tilting has taken place. Last of all, has the unit been installed correctly? Is the frame square? Have the side jambs been overshimmed? Is the sill crowned?

## **Sash is drifting**

If the sash does not stay in place after lifting, the sash shoe may need adjustment to hold the sash tighter against the jamb liner. To adjust the sash shoe, tilt in the sash following the procedure listed in the cleaning glass section. If the sash was too loose, then use a slotted screwdriver to adjust the nylon screw above the locking terminal on each sash shoe. Turning the screw clockwise will tighten the sash operation. After adjusting equal amounts, press sash firmly back into the jamb liners.



## Slide-By Windows

### Operation

To open the window, unlock the sash lock(s) by turning the lever(s) in the direction labeled on the lock. Note: Make sure lock is turned completely open to avoid damage to the lock and window. The window will now slide open. To close the window, reverse these steps. Always lock the sash locks. Locking the window not only keeps the window secure, but holds the sash firmly against the weather strip creating a tight seal.

### Cleaning the Glass

The EAGLE Slide-By Window can be easily cleaned by removing the operable sash from the frame. To remove, open the sash about 3". Next, hold onto sash firmly with one hand while pressing in on the head jamb liner track with the other. Carefully pull sash away from the top until it becomes disengaged from the track. Lean sash against a stable object or set on a table. Then clean both surfaces of the glass. To clean fixed sash on the exterior, reach through the opening, and clean with a squeegee. *Caution: Do not lean out or sit on the window sill. You may lose your balance or fall.* To set the operable sash back into the frame, set the bottom of the sash (bottom has brass rollers) into the sill track, depress the head jamb liner, then snap back into place. For recommended cleaning solutions, see page 9.



*Unlocking the sash.*



*Removing the sash.*



Lifting the screen catches.



Lubricating the track with paraffin.



Making sure the frame is square. Check horizontal, vertical and diagonal measurements.

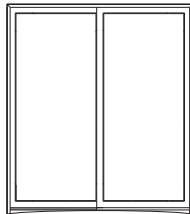

Is the sill crowned?

## Screen Removal

To remove the screen, first open the operating sash to the full open position. Lift the butterfly catches located on the side of the screen. Push the screen toward the exterior and pull outward. Turn the screen and carefully pull inside. To reinstall, reverse the procedure. Make sure the end of the screen opposite the catches is properly seated in the frame. Then lock the catches into the side jamb. *Note: Half screens are available as an option and work on the same principle as full screens.*

## General Maintenance

To help keep your Slide-By Windows operating smoothly, be sure to keep the sill and head jamb liner tracks clean. A mild soapy detergent or denatured alcohol is sufficient for cleaning these surfaces. Do not use abrasive cleaners, as they may scratch the surfaces. Lubricate the tracks with a thin coat of paraffin or a dry silicone spray if needed. *Do not over-lubricate. Apply a little lubricant and experiment.*

To remove the operable sash, refer to the procedure listed under the glass cleaning steps.

## Troubleshooting

### Sash does not open

If the sash does not open, check to make sure the sash locks have been completely disengaged.

### Sash is hard to operate

If the sash is operating hard, check to make sure the sill and head jamb liner tracks are clean of dirt and debris. A thin coat of paraffin or a dry silicone spray may be helpful for lubricating. Check to make sure the sash is seated correctly in the tracks. Also check to make sure window trim nails haven't punctured the head jamb liner. Last of all, has the unit been installed correctly? Is the frame square? Has the frame been overshimmed? Is the sill crowned? If you continue to experience problems, contact your EAGLE representative for assistance.



## **Circle Top and Geometric Windows**

### **Operation**

All EAGLE Circle Top and Geometric Windows are non-operational. In other words, they do not close or open.

### **General Maintenance**

EAGLE Circle Top and Geometric Windows are generally maintenance-free. Clean the glass as needed, and maintain the interior and exterior surfaces on the same schedule as your other windows and doors.

Occasionally inspect the cap bead of sealant between the glass and the exterior glazing leg on Circle Top Windows. If it is damaged or in need of repair, remove and apply new sealant as necessary.



*Caution: On elevated decks and in pool areas, never leave door open and screen in place with children unattended. Screens are designed for insect control only.*



## Patio and French Sliding Doors

### Operation

Patio and French Sliding Doors are available in a variety of handle set options. All handle sets have a locking lever located on the handle assembly. Simply push the lever up to unlock the door. Keyed cylinders are available as an option. An optional security footbolt has two locking positions. It locks when the door is completely shut or with the door open about 3" to allow for ventilation. To lock, simply push down on top round button and engage into the grommets located on the sill. To unlock, push the square button on the outside face of the footbolt.



*Lifting the lever to unlock door.*

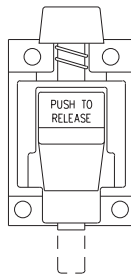

*Security foot bolt.*



*Making sure the track is clean.*

### General Maintenance

To help keep your Patio and French Sliding Doors operating smoothly, check the door track frequently to make sure it is free of dirt and debris. The rollers located on the bottom of the door panel and the locking assembly are adjustable. Please refer to the troubleshooting section for detailed instructions. Your screen door may also require adjustment over time. The rollers are adjustable by turning the adjustment screws located on the bottom and top rails of the screen frame. Please refer to the troubleshooting section for detailed instructions. Make sure screen track is free of dirt and debris in order for screen to operate smoothly. A vacuum

cleaner with a brush attachment is sufficient for cleaning, along with a mixture of mild soap and water. Do not use abrasive cleaners, as they may damage the surface.

## Troubleshooting

### Rough operation of sliding door

If the door is not operating smoothly, there could be a number of possible causes. First, check to see if the track is free of dirt and debris. If not, clean track with a vacuum cleaner and brush attachment. Then lubricate track with a dry silicone spray. If this does not work, the door panel may need adjusting. It may be dragging on the sill track or binding at the top. To adjust the door panel, first remove the plastic hole plugs from the bottom rail of the operating panel. With a phillips or regular screwdriver, adjust the roller to the desired height. To raise the door, turn the adjustment screw clockwise. To lower the door, turn the adjustment screw counterclockwise. Make sure the door panel remains parallel to the door jambs as you are adjusting. In other words, adjust the rollers evenly so the panel remains level and square to the door jambs. When completed, install the plastic hole plugs back into the adjustment holes. Check to see if the unit has been installed correctly. Is the frame square? Is the threshold crowned?

### Door does not latch properly or consistently

If the lock does not latch properly, the lock on the edge of the door panel may need adjusting. A slotted adjustment screw is located above the latch arm. If the door panel is sitting low and not locking into the strike on the door frame, then rotating the screw counterclockwise will raise the latch arm to engage into the strike. If the door panel is sitting high in the frame, then rotating the screw clockwise will lower the latch arm to help engage into the strike. If there isn't enough adjustment in the screw, then loosen the screws on the strike, and slide the strike in the appropriate direction until the lock engages securely.



*Adjusting the door rollers.*

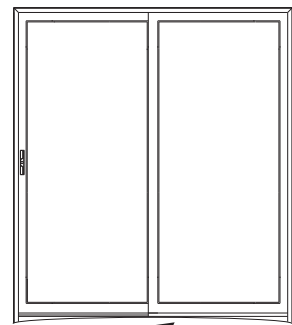

*Is the threshold crowned?*



*Adjusting the latch arm.*



*Adjusting the strike.*



*Adjusting the screen rollers.*



*Adjusting the screen strike.*

### **Screen door does not slide smoothly**

If screen door is not operating smoothly, clean the screen track and remove any dirt or debris. A vacuum with a brush attachment works sufficiently. Then lubricate with a dry silicone spray. Two adjustment screws are located on both the top and bottom rails of the screen. Pry the plastic caps off with a thin putty knife, and adjust the screws to the desired height. Make sure the screen is level and square with the door frame. When completed, replace the plastic caps.

### **Screen door doesn't lock to frame**

If the screen door is not locking to the frame, the strike on the frame may need adjusting. Loosen the screw on the strike or keeper, and move to the desired height. Tighten screw, and try again.



## Hinged French Doors

### Hardware Styles

It is first important to understand the various types of hardware that are available on EAGLE Double French Doors. They are as follows:

A Type 1 door uses the standard opening hardware to open the active panel and shootbolt activated hardware located on the astragal to open the inactive panel. Only the active panel has a handle set.

A Type 2 door uses the standard operating hardware to open the active panel, and shootbolt activated hardware located on the astragal to open the inactive panel. The active panel has an operating handle set and the inactive panel has a dummy handle set.

A Type 3 door uses the standard operating hardware to open the active panel and manually activated hardware located in the stile of the inactive panel to open the inactive panel. The active panel has an operating handle set and the inactive panel has a specially designed inactive handle set.

Single French Doors use the standard operating hardware to open the operating panel.

## Active Trim and Lever Installation Instructions (Type 1, 2 and 3 Doors)

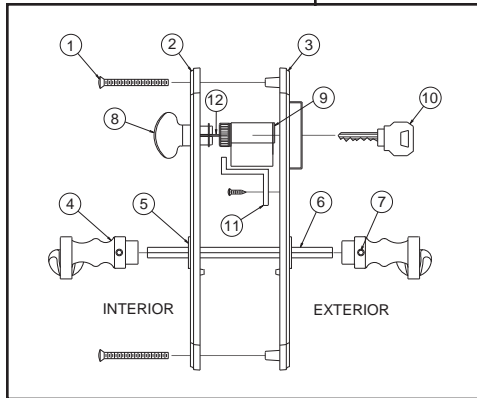

Standard Operating Handle for  
Type 1, 2 and 3 doors.

1. Insert locking cylinder #9 into the outside escutcheon plate #3 using the "Z" bar #11 to secure the cylinder to the escutcheon plate.
2. Insert cylinder and outside escutcheon plate into door by first inserting tail piece #12 through the upper slot in the lock body in the door panel.
3. Install inside escutcheon plate #2 making sure the tailpiece of cylinder #12 is inserted into the slot on the thumbturn #8.
4. Attach outside and inside escutcheon plates together with the screws #1 provided. Do not tighten screws all the way.
5. Insert spindle set screws #7 provided into levers #4 as shown. Do not tighten.
6. Place nylon washers #5 over shank of levers #4 as shown.
7. Attach one lever #4 to spindle #6 making sure the split in the spindle will receive set screw on lever. Tighten set screw #7 with allen wrench provided.
8. With the lever in the horizontal position, insert spindle #6 through outside escutcheon plate #3, through lower square hole on lock body and through inside escutcheon plate #2.
9. Slide remaining lever #4, nylon washer #5 and set screw #7 onto spindle #6 and adjust trim as necessary to accept lever.
10. Engage and disengage the locking points several times. When the handle operates smoothly, tighten the bottom trim screw #1. Next, with the locking points in the engaged position, operate the key and thumbturn several times until both function smoothly. Tighten top trim screw #1 and set screw #7. Do not over tighten as damage can result to the escutcheon plate.

## Dummy Trim and Lever Installation Instructions (Type 2 Doors)

1. Locate the centerline of the lever to the same center line location as that on the active door.
2. Attach a dummy plate #8 to each side of the door with the screws #9 (provided). Position the split on handle so that the center of the spindle is at the centerline of lever and that the beveled split on spindle is properly oriented to receive set screw #7 on lever.
3. Fit outside escutcheon plate #3 onto door making sure spindle on dummy plate is centered in lever hole on escutcheon plate.
4. Fit inside escutcheon plate #2 onto door as in step 3. Attach both escutcheon plates together with screws #1 (provided).
5. Install set screw #7 into lever #4.
6. Place nylon washers #5 over shank of levers #4 as shown.
7. Attach one lever to spindle on dummy plate #8, and tighten set screw #7.
8. Attach other lever as in step 7, and adjust trim as necessary to accept levers.
9. Tighten trim screws #1 and set screws #7. Do not over tighten as damage can result to the escutcheon plate.

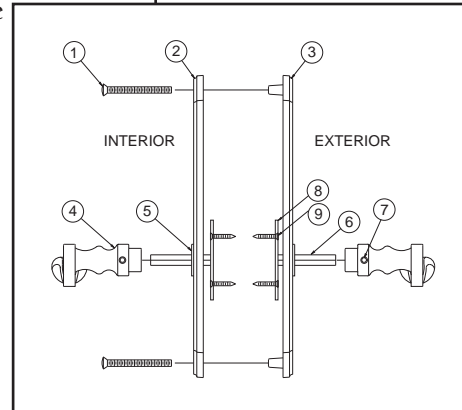

*Dummy Handle for Type 2 doors.*

## Inactive Trim and Lever Installation Instructions (Type 3 Door)

1. Insert half spindle tailpiece #9 on thumbturn #8 on inside escutcheon plate #2. To accomplish this, rotate the "C" clips on the thumbturn until the slot on the clips are aligned with the slot on the thumbturn. Insert the "V" side on the tailpiece into the slot on the thumbturn, and rotate

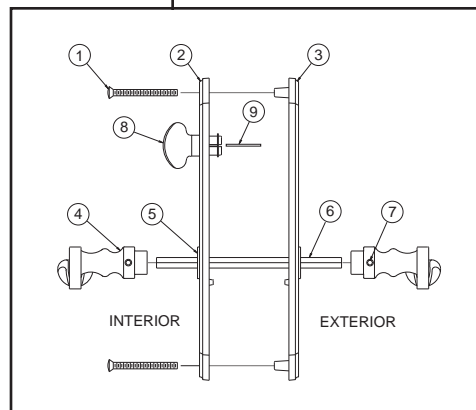

*Standard Inactive door panel handle for Type 3 doors.*

the "C" clips again to prevent the tailpiece from coming out.

2. Install inside escutcheon plate #2 with attached tailpiece #9 by first inserting tailpiece through small slot on lock body then gently pushing inside escutcheon plate flat against the door.
3. Assemble the outside plate #3 and inside plate #2 together with attachment screws #1 provided. Do not tighten screws all the way.
4. Insert spindle set screws #7 provided into levers #4 as shown. Do not tighten.
5. Place nylon washers #5 over shank of levers #4 as shown.
6. Attach one lever #4 to spindle #6 making sure the split in the spindle will receive set screw on lever. Tighten set screw #7 with allen wrench provided.
7. With the lever in the horizontal position, insert spindle #6 through outside escutcheon plate #3, through lower square hole on lock body and through inside escutcheon plate #2.
8. Slide remaining lever #4, nylon washer #5 and set screw #7 on spindle #6. Adjust trim as necessary to accept lever.
9. Engage and disengage the locking points several times. When the handle operates smoothly, tighten the bottom trim screw #1. Next, with the locking points in the engaged position, operate the key and thumbturn several times until both function smoothly. Tighten top trim screw #1 and set screw #7. Do not over tighten as damage can result to the escutcheon plate.
10. Note: Make sure head and footbolts are in the retracted position before closing door panel.

## Operation

Your EAGLE Autolatch® French Door is supplied with an advanced multi-point locking system which provides exceptional security and excellent sealing pressure. To open the door from the interior, first make sure the deadbolt turn knob is disengaged. (When the thumb turn is in the vertical position, the door is unlocked.) Then, simply pull down on the lever to release the locking pressure. To close, swing the door



*Turning the deadbolt knob.*

shut. When the top and bottom latchbolts push against the strike plates, locking they fire a full 1" into the strike and automatically lock the panel tight to the frame. To complete the locking procedure, advance the deadbolt thumb turn knob so that it is in the horizontal position. A keyed cylinder also allows the door to be locked securely from the exterior.

To open the inactive door panel on a Type 1 or 2 Double French Door, open the active panel first. Then flip the shootbolt lever located on the top edge of the inactive panel. This will activate the astragal hardware and allow the door to open. Reverse the above steps to close the door.

To open the inactive door panel on a Type 3 Double French Door, open the active panel first. Then, simply pull down on the lever of the inactive door panel to release the locking pressure. The door will then open. Reverse the above steps to close the door.

## General Maintenance

The sill on your French Door may require occasional cleaning. Keep the water channel on the sill free of any dirt or debris. This will prevent water from building up and allow it to flow away from the door. The top aluminum section of the sill may be removed on a door frame for cleaning purposes. Remove the screws on the front exterior of the sill first. Then pry up the top plate as illustrated in figure. Never caulk in front of the weep holes on the front exterior of the sill. This would prevent water from exiting the water channel.

The door sweep bottom weather-strip can be replaced if needed and is available through your local EAGLE representative. Simply slide the sweep off the metal weather-strip receptor on the bottom of the door panel. *Note: Weather-strip on some models is kerf mounted. To remove, simply pull weather-strip from kerf, and press new weather-strip firmly into kerf.*

EAGLE French Doors are available with two styles of hinges – an oil-impregnated, heavy-duty commercial



Pulling down on operator lever.

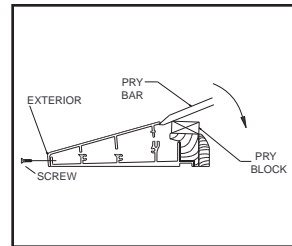

Prying up the sill top plate.

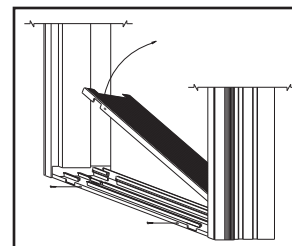

Removing the sill top plate.



Door Sweep.

**Commercial Grade Hinge**

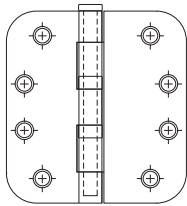

OIL-IMPREGNATED  
HEAVY-DUTY  
COMMERCIAL GRADE  
HINGE

grade hinge or a 2-way adjustable hinge. Check to see which style your door is furnished with. Neither style requires oiling. However, as new homes settle over a period of months, it may become necessary to readjust the adjustable hinges. For detailed instructions, see the troubleshooting section.

All moveable parts of the locking mechanism may be lubricated with a dry silicone spray as needed. Do not use oil or grease, as it may attract dirt and debris.

**Troubleshooting**

**Door does not latch tight**

Check to make sure the latchbolts are engaging in the strike plates properly. If they are not, it is possible that the door is out of square in the opening. Check to see if the unit has been installed correctly. Is the frame square and plumb? Is the sill crowned?

**2-Way Adjustable Hinge**



Horizontal adjustment of hinge.

**Door drags on sill,  
or reveal around door is unequal**

If the door is dragging on the sill during operation or the reveal between the frame and the panel are not equal, first check to make sure the unit has been installed correctly. Is the frame square and plumb? Is the sill crowned?

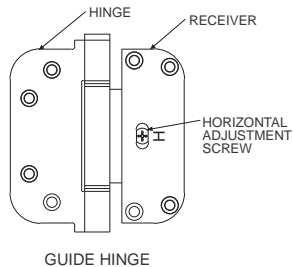

GUIDE HINGE

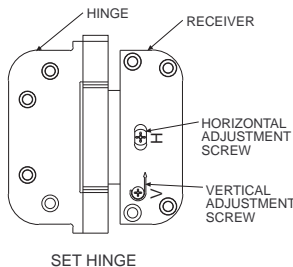

SET HINGE

Then check to see what type of hinges are included with your door as noted earlier in the General Maintenance section. Hinge placement for all French Doors is factory-located to the correct specifications. However, if the door has 2-way adjustable hinges, it may be possible that the hinges themselves require some adjustment. The two-way hinge system consists of two types of hinges. Each door consists of two GUIDE HINGES, (one top and one bottom) which are capable of horizontal adjustment. The adjustment screw is marked with an "H". The door will also have one middle SET HINGE which is capable of both horizontal and vertical adjustment. The SET HINGE has two adjustment screws, one marked "H" and one marked "V." To adjust the door vertically, open the door panel 90 degrees, and turn the adjust-

ment screw marked with a "V" on the middle SET HINGE. Turning the screw in the direction the "V" arrow points will actually adjust the door panel in the opposite direction of the arrow. To adjust the door panel horizontally, keep door panel open 90 degrees, and turn the horizontal adjustment screws marked "H" on all three hinges. Turning the screws clockwise will increase the gap between the sash and frame on the hinge side. To tighten this margin, turn the screws counter clockwise. *Note: Do not dismantle the hinge by knocking out the pin unless the hinge and hinge receiver are unattached from the door. Removing the pin with the weight of the door on the hinges could seriously affect the maintenance-free hinge bearings.*

### **Water is building up in the sill channel**

If water is building up in the sill, the weep holes in the sill are probably clogged. To drain the water, the sill channel must be cleaned out. The top can be removed to aid in this process. To remove top plate, see the instructions listed in the General Maintenance section.

### **Air Infiltration**

Check all of the perimeter frame weather-stripping and bottom door sweep weather-strip. All weather-stripping is easily replaced and is available from your local EAGLE representative. Check the bottom jamb corners for door pads. If missing, replace.



## Entry Doors

### Operation

Operation is dependent upon the operating hardware furnished by others. EAGLE does not supply locksets and deadbolt. Follow the manufacturer's instructions for installation and operation.

### Finishing

Finishing your EAGLE entry doors requires a variety of procedures that differ from those listed in the front of this manual. The following procedures are required for the EAGLE Steel Door, EAGLE Stainable Steel Door and the EAGLE Premier Door:

#### The EAGLE Steel Door

EAGLE's steel door is pre-painted with a high quality primer. Small scratches and abrasions that occur during shipping and installation are common and will not effect your door once it is finish painted. Finish painting will also maintain its great looks and must be done to meet warranty requirements. First, prepare the surfaces for painting by removing any dirt, fingerprints and/or oil with a sponge or soft

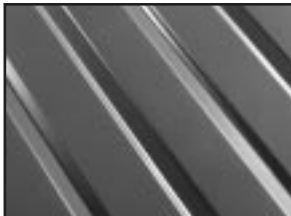

*EAGLE's steel doors provide a perfectly smooth surface for a consistent, even painted finish.*

brush and mild detergent. Wipe dry. Sanding the prime finish is not necessary. Paint the inside and outside surfaces and all edges of the door with a high quality exterior grade acrylic latex paint. Do not paint the vinyl weather-strips. Do not close the door until the paint is dry. *Note: Do not paint exterior of door a dark color. Excessive heat transmission could cause damage to door and its operation.*

### **The EAGLE Stainable Steel Door**

The EAGLE Stainable Steel Insulated Entry Door system has been engineered to provide a high quality "wood look" entry system. The attractive wood grain pattern has been selected from the most attractive oak grain structure and assembled in a true stile and rail design. Additional detail has been added to the plaque design which enhances the curb appeal of your insulated entry system. Properly finishing your new stainable entry system will offer the appearance of wood. Finishing a wood product or a stainable steel door is an art that can be accomplished by the novice or the professional. For the best appearance, use EAGLE's Artist Oil Stain Kit. Zar-type stains can also be used and are available at most hardware stores.



*Stainable steel doors have an authentic embossed woodgrain texture ideal for staining in your choice of wood finishes. The specially developed top coating allows our textured steel doors to readily accept stains or paint, just like real wood.*

## EAGLE ARTIST OIL STAIN KIT

### MATERIALS REQUIRED

- (2) tubes (37 ml, 1.25 oz.) of artist oil
- (1) 4oz. can of mineral spirits
- (1) 4oz. mixing bottle
- (2) Clean, cotton cloth rags
- (1) 12oz. aerosol can of high quality, exterior grade, UV resistant, satin finish polyurethane clear top coat
- (1) pair of plastic gloves
- (1) 4" wide foam brush
- (1) 2" wide foam brush
- Lamb's wool (approx. 3" x 3")
- No. 7445 White Scotch Brite Pads (Optional—not included in Stain Kit)
  - \* Included in Artist Oil Stain Kit available from EAGLE

The following instructions outline the recommendations that provide the highest quality finish. It is recommended that the door be stained horizontally while supported by saw horses. However, the door can be stained while hung in the opening.

1. Pour about one-third of the mineral spirits provided (1  $\frac{1}{3}$  oz.) into the glass bottle. Squeeze the entire contents of one tube of artist oil into the container. Mix thoroughly (shake the bottle with the lid on).

NOTE: If you are looking to achieve a dramatic effect with an unusual color, you can mix your own stain using basic artist oils and mineral spirits. Any good artist oil (Permalba or Grumbacher) mixed with mineral spirits will work nicely. Mix approximately one part mineral spirits to one part artist oil paint.

2. Before applying the stain, make sure the door is completely clean and free of any fingerprints, grease marks or dirt. Wiping the surface with a small amount of mineral spirits on a clean cloth is recommended. Allow to dry.

3. Working with the embossed areas first, apply a small amount of stain with the lamb's wool provided. Apply just enough to fully darken the surface.
4. **IMPORTANT:** Allow the stain to set up for 15 to 30 minutes or until tacky. Stretch the cotton material over the 4" foam brush so that the grain of the cloth runs horizontally on the brush. Then with the wide flat side of the brush, carefully begin to brush off the excess stain, working with the grain in the embossed areas.

Use the 2" foam brush with cotton material stretched around it as described for the 4" brush or the lamb's wool to remove the excess stain in the edges of the embossments. (The optional No. 7445 White Scotch Brite Pad may also be used). Always brush in the direction of the grain.

After removing the excess stain from the embossments, stand back and examine them. Look for obvious variations in darkness. If the color is too dark, go over it again in the same manner.

**REMEMBER:** The more you brush, or the more pressure you apply, the lighter the stain will appear. Continue to brush the door lightly (always with the grain) until you are satisfied with the relative darkness and uniformity of the stain. Be sure to remove the excess stain in the corners of the embossments. Do this with a cotton swab or piece of cloth twisted into a fine point.

5. In a similar manner, finish staining the rest of the door. Use a piece of cardboard or a metal ruler to mask the door edge for a more finished look. If you are finishing the door in place, proceed to the other side and complete the staining process before you apply the finish coat. Let the stain dry overnight before topcoating. Hold the aerosol can of clear coat (polyurethane) 12 to 14 inches away from the surface of the door. With a gentle, sweeping motion from side to side, apply a light coat of clear finish from the top down. Allow to dry per manufacturer's instructions.

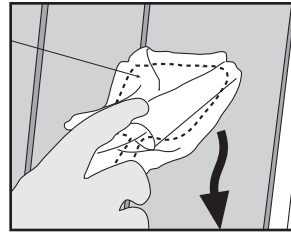

*"Graining" the stain by using a foam brush to remove the excess stain.*

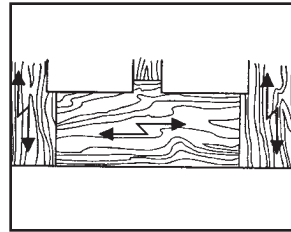

*"Graining" the stain is accomplished by brushing the stain with the grain lines to the desired color consistency.*

6. The glasslite trim utilized in your new stainable entry system has also been engineered to provide the same high quality "wood look" that is offered in the door or sidelite panel. The same finishing guidelines should be utilized to finish this component of your entry system.
7. For quick touch-ups after the door is finished, use a cotton swab with stain straight from the tube and lightly apply to the door. Dab off excess with a soft cloth. Retouch lightly with a spray clear coat.

#### **FOR A STAINED DOOR USING ZAR-TYPE STAIN**

##### **MATERIALS REQUIRED**

- High quality stain, approximately one pint.  
(Zar has tested satisfactorily)
- High quality, exterior grade, UV resistant, satin finish polyurethane clear top coat in a 12 oz. aerosol can
- Mineral spirits
- Clean, soft cotton cloth
- Foam brushes, 4" and 2" wide
- 2" Synthetic bristle brush (Optional)
- Lamb's wool (approx. 3" x 3") (Optional)
- No. 7445 White Scotch Brite Pads (Optional)

The following instructions outline the recommendations that provide the highest quality finish. It is recommended that the door be stained horizontally while supported by saw horses. However, the door can be stained while hung in the opening.

1. Before applying the stain, make sure the door is completely clean and free of any fingerprints, grease marks or dirt. Wiping the surface with a small amount of mineral spirits on a clean cloth is recommended. Allow to dry.
2. Working with the embossed areas first, apply a small amount of stain with a soft piece of cloth. Apply just enough to fully darken the surface. (The optional lamb's wool aids in staining the embossed area.)
3. **IMPORTANT:** Allow the stain to set up for 15 to 30 minutes or until tacky. Stretch the cotton

material over a 4" foam brush so that the grain of the cloth runs horizontally on the brush. Then with the wide flat side of the brush, carefully begin to brush off the excess stain, working with the grain in the embossed areas. Use a 2" foam brush with cotton material stretched around it as described for the 4" brush or lamb's wool to remove the excess stain in the edges of the embossments. (The optional No. 7445 White Scotch Brite Pad may also be used.) Always brush in the direction of the grain.

After removing the excess stain from the embossments, stand back and examine them. Look for obvious variations in darkness. If the color is too dark, go over it again in the same manner.

*REMEMBER: The more you brush, or the more pressure you apply, the lighter the stain will appear. Continue to brush the door lightly (always with the grain) until you are satisfied with the relative darkness and uniformity of the stain. Be sure to remove the excess stain in the corners of the embossments. Do this with a cotton swab or piece of cloth twisted into a fine point.*

4. In a similar manner, finish staining the rest of the door. Use a piece of cardboard or a metal ruler to mask the door edge for a more finished look. If you are finishing the door in place, proceed to the other side of the door, and complete the staining process before you apply the finish coat. Let the stain dry overnight before topcoating. Hold the aerosol can of clear coat (polyurethane) 12 to 14 inches away from the surface of the door. With a gentle, sweeping motion from side to side, apply a light coat of clear finish from the top down. Allow to dry per manufacturer's instructions.
5. The glasslite trim utilized in your new stainable entry system has also been engineered to provide the same high quality "wood look" that is offered in the door or sidelite panel. The same finishing guidelines should be utilized to finish this component of your entry system.
6. For quick touch-ups after the door is finished, use

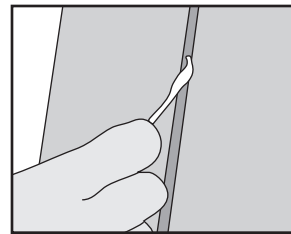

*Removing the excess stain from the corner of the embossments with a cotton swab.*

a cotton swab with stain and lightly apply to the door. Dab off excess with a soft cloth. Retouch lightly with a spray clear coat.

#### FOR A PAINTED DOOR

##### MATERIALS REQUIRED

- High quality, exterior grade acrylic latex paint, approximately 1 quart.
  - High quality, synthetic bristle paint brush.
1. Apply a high quality exterior grade acrylic latex finish paint using a synthetic bristle brush. Finish paint should be applied with the grain to provide the best results.

NOTE: All exposed surfaces of your entry system, including the top and bottom edges require finishing to insure proper weatherability.

2. Allow the paint to cure per the manufacturer's specifications. The finished surfaces should be stored in a condition that does not allow contaminants to settle on the uncured finish.
3. The glasslite trim utilized in your new painted entry system has also been engineered to provide the same high quality "wood look" that is offered in the door or side-lite panel. The same finishing guidelines should be utilized to finish this component of your entry system.

##### The EAGLE Premier Door

EAGLE's Premier Door is steel on the exterior and natural wood on the interior. For painting the exterior, please follow the instructions listed for the EAGLE Steel door listed earlier. For staining or painting the interior, please follow the interior finishing instructions for windows and doors as seen in the front of this manual.



*Premier doors have real wood on the interior allowing your choice of wood finishes.*

## General Maintenance

The bottom door sweep weather-strip can be replaced if needed and is available through your local EAGLE representative. Simply slide the sweep off the metal weather-strip receptor on the bottom of the door panel. Replacement perimeter frame weather-strip is also available and is easily applied by pushing into the kerf on the frame.

Your entry door is equipped with adjustable hinge plates inside of the door and may be moved in or out and up or down. If it is necessary to shift the door after the jamb has been secured, loosen the screws (only those which fasten the hinge leaf to the door) just enough to move door into proper position then re-tighten screws.

Clean the sill on your door frequently, and keep it free of dirt and debris. To adjust the sill, please read the Troubleshooting section.

## Troubleshooting

### The door drags on the sill

If the door drags over the sill during operation, the hinges may need adjustment. See the hingement instruction in the General Maintenance section. The sill is also adjustable and may require lowering. To adjust the sill so the bottom weather-strip on the door sweeps the sill evenly, loosen the lock screws, and turn the adjusting screws to the desired level. When completed, re-tighten the lock screws.



*Vinyl 6-finger bottom weather-stripping fits securely into the threshold channel for a weathertight seal and can be replaced without removing the door. Advanced foam compression perimeter weather-stripping (not shown) provides an airtight seal to keep out water and air.*



*Adjustable hinge plate system.*



*Adjustable, weathertight threshold.*



## Wood Grilles

### Finishing

Remove grille from sash before staining or finishing. For finishing guidelines, please follow the instructions for window and door finishing located at the beginning of this Owner's Manual.

### General Maintenance and Cleaning

EAGLE offers two styles of wood grilles - stick grilles and full surround grilles. To clean grilles and/or the glass behind the grilles, follow the instructions listed below. Clean grilles with a damp cloth if required. Do not use turpentine or mineral spirits.

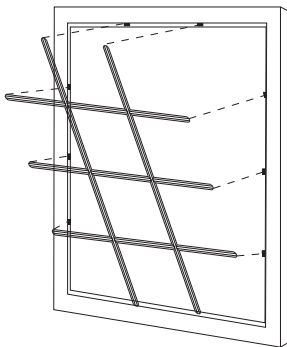

*Reinstalling a grille.*

**Stick Grilles** - To remove a stick grille from the window, gently pull the grille away from the window at the end of each bar. Start from the bottom vertical bars and move to the horizontal bars on one side. Once one side of the horizontal bars has been disengaged, the grille should then easily be removed. Be careful not to bend the grille bar so much as to break it at the dado joint. To reinstall grille into window sash, start by inserting the bottom vertical bars into the metal grille fasteners. Then bow the grille and insert the alternate left and right tips, moving from the bottom to the top (see illustration). Last, bow the top vertical bars and snap into place. Again, be gentle and careful not to over extend the bar.

**Full Surround Grilles** - To remove a full surround grille from the window, gently pull the grille away from the window by lifting the wood surround away from the glass. Start from the bottom and move to one side. Gradually work your way around the grille until it can easily be disengaged. Be careful not to bend the grille bar so much as to break it at the dado joint. To reinstall grille into window sash, start by inserting the bottom of the grille into the metal grille fasteners. Then gently snap the surround into the fasteners moving from the bottom to the top. Again, be gentle and careful not to over extend the bar.

### Installing a New Grille

If you are installing a new grille for the first time, please follow these instructions.

**Stick Grilles** - Remove grille bars from packaging, and lay out on a flat surface. Use a quality wood glue in the dado joints of the horizontal bars only. Carefully snap all joints together, and allow glue to set. Next, insert grille into window sash. With a pencil, lightly mark the glass stop where each bar intersects the stop. Remove the grille. Next, insert metal fasteners (knife end first) behind the glass stop and tape. Make sure the fastener is tight against the glass (See illustration). Push the fasteners tightly toward the glass stop. Reinstall the grille according to the instructions listed under the General Maintenance and Cleaning section.

**Full Surround Grilles** - Remove assembled grille from packaging. Insert metal fasteners as follows: Center a clip between each daylight opening created by the vertical bars along the bottom glazing stop.

**Operating Unit Widths** - A total of two clips are to be applied, equally spaced, at the top of each unit.

**Fixed Unit Widths** - For sash widths up to and including 59", a total of two fasteners are to be applied, equally spaced, at the top. For sash widths greater than 59", a total of three fasteners are to be applied, equally spaced, at the top.

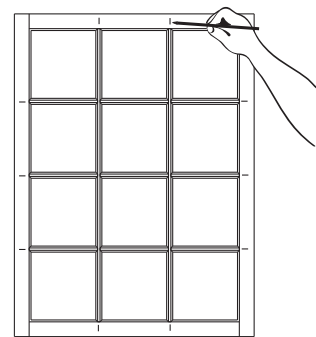

Mark location of grille clips.

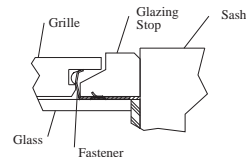

KD Grille and fastener.

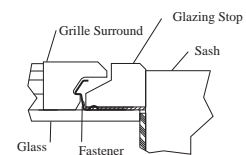

Full Surround Grille and fastener.

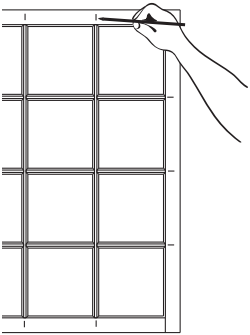

## Blinds and Shades

### Operation

EAGLE offers three styles of blinds and shades :

- 1.) System 1 - 1" Aluminum Slat Free-Hanging Blinds
- 2.) System 2 - 1" Aluminum Slat Between-the-glass Blinds
- 3.) System 2 - 1 3/8" Fabric Cellular Shades

**System 1 Blind** - The System 1 blind hangs from the head stop between the sash and the screen. To open or close the blind, turn the tilt control knob located on the sill cover of the window. To raise the blind to a stacked position, remove screen and pull down the ring attached to the cord at the top of the blind. When blind is at the stacked position, clip the ring over the hold down pin mounted on the side stop of the frame. Reinstall screen. To lower, reverse these procedures.

**System 2 Blind** - The System 2 blind is attached to a storm panel frame which is in turn attached to the sash of the unit. The blind is therefore encased in a dust-free environment. To open or close the

blind, turn the tilt control knob located on the bottom of the storm panel. To raise the blind, pull down on the drawstring to the desired position. The drawstring is secured by a spring-loaded cord lock that is fastened to the side of the window. Always keep the drawstrings out of the reach of children. To lower the blind, hold on to the drawstring and push in on the cord lock. The blind may then be lowered to the closed position.

**System 2 Cellular Shades** - The System 2 shade is attached to a storm panel frame which is in turn attached to the sash of the unit. The shade is therefore encased in a dust-free environment. To raise the shade, pull down on the drawstring to the desired position. The drawstring is secured by a spring-loaded cord lock that is fastened to the side of the window. Always keep the drawstrings out of the reach of children. To lower the shade, hold on to the drawstring, and push in on the cord lock. The shade may then be lowered to the closed position.

### General Maintenance

All three are virtually maintenance free. However, occasional cleaning may be required. To clean a System 1 blind, first remove screen from frame. Next tilt the blinds in a downward position and use a vacuum cleaner with a brush attachment to remove dust. For fingerprints or dirt, use a damp cloth. Tilt the blind the opposite direction and repeat procedure. Reinstall screen when completed.

To clean a System 2 blind, first remove the screen. Note: The blind drawstring is routed through a screen grommet in the screen. Remove the drawstring from the screen. Loosen the storm panel clips around the exterior of the storm panel, and remove the storm and blind system. Then, tilt the blinds in a downward position, and use a vacuum cleaner with a brush attachment to remove dust. For fingerprints or dirt, use a damp cloth. Tilt the blind the opposite direction, and repeat procedure. To clean the interior glass of the storm panel, pull blind to the stacked position, and wash the glass. When complete, reverse these procedures, and reinstall the screen.



*Cleaning blinds.*



Loosen clips on System 2 storm panel.



Cleaning shades with brush attachment.

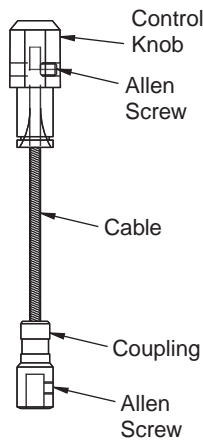

Make sure the allen screw is tight on D-rod.

To clean a System 2 fabric shade, first remove the screen. Note: The shade drawstring is routed through a screen grommet in the screen. Remove the drawstring from the screen. Next, loosen the storm panel clips around the exterior of the storm panel, and remove the storm and shade system. Next, use a vacuum cleaner with a brush attachment to remove dust. For fingerprints or dirt, use a damp cloth. Do not use cleaners with ammonia. This will damage the fabric of the shade. To clean the interior glass of the storm panel, pull shade to the stacked position and wash the glass. When complete, reverse these procedures and reinstall the screen.

## Troubleshooting

### Blinds don't operate

First check screen installation of the window unit. If the frame is out of square or if the sill is crowned, this needs to be corrected.

Remove the screen, and turn the control knob on the storm panel. If the blind operates, the problem is in the screen transition. The screen transition location may be out of place.

If blind does not operate when turning the storm panel control knob, the problem may be in the control knob and or D-rod. Remove the storm panel, turn the control knob, look at the coupling attached to the cable coming off the control knob and also the coupling coming out of the blind assembly. Is the D-rod turning as you turn the control knob? If not, tighten the allen screw on each coupling.

### Control knob is not turning

Remove storm panel, remove control knob from the storm panel, enlarge hole in the storm panel that the control knob came out of by  $\frac{1}{64}$ ". Reinstall the control knob.

## EAGLE 20/10 Non-Prorated Limited Warranty



### EAGLE Window and Door Limited Warranty

#### INSULATED GLASS

EAGLE WINDOW & DOOR, INC., as manufacturer, warrants all insulated glass (including Decorelle 100 and 150) delivered to the original consumer by EAGLE WINDOW & DOOR, INC., or its authorized dealers against, (1) failure of the air seal for a twenty (20) year period from the date of manufacture - decorative glass (Decorelle 250 - 700) for ten (10) years from date of manufacture, (2) this failure due to stress crack or thermal shock cracking for a period of two (2) years from date of manufacture. This Warranty does not include cracked or broken glass or damage to the product resulting from accident, abusive handling or misuse. Films, coatings or other appliances applied to the glass on EAGLE products will immediately void the Warranty. Should there be such failure of the air seal within the Limited Warranty period, EAGLE WINDOW & DOOR, INC., shall provide either a replacement piece of insulated glass or a sash glazed with insulated glass, at their discretion, delivered to the original point of purchase. The consumer will be responsible for installation and replacement of the glass. EAGLE WINDOW & DOOR, INC., will not be responsible for repainting, refinishing, or similar activities involved in the installation and replacement of glass.

#### WOOD ITEMS

EAGLE WINDOW & DOOR, INC., warrants to the original consumer the quality of workmanship and materials of wood items to be free from defects which might render the product unserviceable. We suggest inspection of all products upon arrival and before installation and finishing. Texture and color variations do not constitute defects in wood items. To comply with this Limited Warranty, it is the consumer's responsibility to properly care for and protect all wood items against moisture, excessive dryness, etc., and to see that all surfaces, interior and exterior, top and bottom of wood items, are thoroughly painted, varnished, or sealed immediately by accepted field finishing standards. EAGLE WINDOW & DOOR, INC., will, without charge, replace or repair any products which may be defective and will do so in the same state as originally furnished. The company will not accept responsibility for repainting, refinishing, or any other necessary work to complete the replacement or repair of the product. We do ask for prompt and immediate notification of any items deemed unsatisfactory.

Under no circumstances will EAGLE WINDOW & DOOR, INC., warrant the wood items of the product beyond a ten (10) year period which commences from the date of manufacture.

EAGLE WINDOW & DOOR, INC., may defer remedying any Wood Defect for a period of one (1) full year from date of the company's receipt of claim. This one (1) year grace period may be used because window and door products quite often stabilize themselves and return to their original plane as they adjust to various conditions.

## **HARDWARE, WEATHER-STRIPPING, SCREENS, ETC.**

These products are generally manufactured by others and provided to us as raw products to incorporate into our product. We will, however, provide a Limited Warranty to the original consumer against defects for a ten (10) year period from the date of manufacture (except polished brass finished hardware). Within that time period we will provide replacement hardware, weather-stripping, blinds and screens at no cost to the original consumer. The company will not, however, be responsible for installation or any refinishing work associated with replacement of the items deemed defective. Dealers should note the company will invoice at regular price for replacement material, and in turn issue credit when defective material has been returned for inspection and approval. Weathering of hardware finishes may vary and is not considered a defect. Note: Screens are designated for insect control and not for restraining consumers from potential falls from windows and doors.

## **EXTERIOR PAINTED ALUMINUM SURFACES**

Subject to the conditions described below, EAGLE WINDOW & DOOR, INC., shall warrant the paint performance on its aluminum cladding for its standard and designer colors for a period of ten (10) years from the date of manufacture to the original consumer. Custom colors will be warranted for paint performance for a period of one (1) year from the date of manufacture to the original consumer. Within these time periods EAGLE WINDOW & DOOR, INC., warrants that the film will not crack, check, peel, flake, blister, or lose adhesion when exposed to normal atmospheric conditions. The paint performance will vary based on installation in heavy salt spray environments, elevation, orientation, altitude, and other atmospheric conditions. Normal, regular maintenance of the product is recommended to maintain the appearance and extend the finish life on clad units. Units subject to the detrimental effects of air pollutants or chemical or caustic washes will not be covered by the terms of this Warranty. In the event that a paint failure should occur, EAGLE WINDOW & DOOR, INC., reserves the right to determine the best method for taking corrective action.

## **STRUCTURAL PERFORMANCE**

EAGLE WINDOW & DOOR, INC., warrants its extruded aluminum cladding for the life of the product, when properly installed in its intended usage and under normal conditions to maintain its structural performance, shape, and profile.

## **DEFECTS NOT COVERED BY WARRANTIES**

These Warranties do not cover the following defects:

1. With respect to any Wood Defect,
  - a) texture and color variations
  - b) warping unless the "warp" exceeds 1/4" in the plane of an EAGLE window or door itself and not the relation of an EAGLE window or door to the frame or jamb in which it is hung. The term, "warp," means the amount of bow, cup or twist in the window or door panel. When measuring the amount of warp present in an EAGLE window or door panel, place a straight edge, taut wire or string on the suspected concave face of the EAGLE window or door. This action can be performed at any angle (horizontally, vertically or diagonally) while the EAGLE window or door is in its installed position. The measurement of bow, cup or twist must be made at the point of maximum distance between the bottom of the straight edge, taut wire or string and the face of the window or door.

2. With respect to any Air Seal Defect of Products of Others, any cracking or other breaking of glass occurring after the purchase.
3. Any defect not primarily and directly caused by the company's design or manufacture, such as defect due to:
  - a) Normal weathering
  - b) Faulty or improper installation, other installation in non-conformity with industry standards or use of frame, jamb or accessories, which do not properly receive or secure the EAGLE window or door.
  - c) Deterioration, movement or casualty in frame, jamb, wall or building, upon which the EAGLE window or door has been installed.
  - d) Catastrophic weather or act of God, including fire, wind or wind-borne object.
  - e) Vandalism; misuse; physical abuse; intentional act; unreasonable use; accident; negligence (other than negligence in the company's designing or manufacturing of EAGLE windows and doors); atmospheric pollution; acid rain; harmful chemicals; fumes or cleaning compounds; or faulty or improper, or failure to provide reasonable and necessary, maintenance and care against moisture, excessive dryness and other abnormal exposure (including failure to assure that all surfaces, interior and exterior, top and bottom are thoroughly painted, varnished or sealed by accepted field finishing standards).
4. With respect to auxiliary/direct set frame windows and products manufactured by distributors and dealers from components supplied by EAGLE Window and Door, Inc., EAGLE Window and Door, Inc., warrants to the original consumer the materials manufactured by EAGLE Window and Door, Inc., Dubuque, Iowa only. Additional glass, window components, and products sold by EAGLE distributors or dealers (not manufactured by EAGLE Window and Door, Inc.), are not covered under this Warranty.

#### **LIMITATION OF LIABILITIES**

These Warranties are the only express warranties provided by the company. No employee, representative or agent of the company nor any other person has authority to assume or incur on behalf of the company and liability, obligation or responsibility in place of or in addition to these Warranties. IN NO EVENT SHALL THE DURATION OF ANY IMPLIED WARRANTY OF MERCHANTABILITY OR FITNESS FOR A PARTICULAR PURPOSE BE LONGER THAN THE APPLICABLE PERIOD UNDER THIS WARRANTY. SOME STATES DO NOT PERMIT ANY LIMITATION ON THE LENGTH OF AN IMPLIED WARRANTY, AND THEREFORE THE IMMEDIATELY PRECEDING SENTENCE MAY NOT APPLY. IN NO EVENT SHALL THE COMPANY BE LIABLE OR OBLIGATED FOR CONSEQUENTIAL, INCIDENTAL, SPECIAL, INDIRECT OR PUNITIVE DAMAGES OF ANY KIND. SOME STATES DO NOT ALLOW EXCLUSION OR LIMITATION OF INCIDENTAL OR CONSEQUENTIAL DAMAGES, AND THEREFORE SOME OR ALL OF THE IMMEDIATELY PRECEDING SENTENCE MAY NOT APPLY. These Warranties provide specific legal rights, and other rights, which vary from state to state, that may be available.

#### **TRANSFER OF WARRANTIES**

These Warranties are not transferrable by the original purchaser.

## CLAIM PROCEDURE

It is suggested that each EAGLE window and door be inspected upon receipt of delivery and before installation and finishing. To initiate claim action under these Warranties, the original consumer must contact:

Customer Satisfaction Department  
EAGLE Window and Door, Inc.  
P.O. Box 1072  
Dubuque, Iowa 52004-1072

The company must receive each claim within the applicable Warranty period and also within sixty (60) days after the date the defect is first discovered or reasonably could have been discovered. The claim must contain a brief written description of the following:

1. The original consumer's name, address and telephone number.
2. Description of EAGLE window or door involved in claim.
3. Proof of date of purchase (invoice).
4. Name of dealer from which the EAGLE window or door was purchased (if known).
5. Nature of defect and any further pertinent information.

Subject to the third paragraph under the heading, "Wood Items," the company will reply within a reasonable period of time after receipt of the claim. For a claim to be honored, the consumer must also provide to the company other information and evidence reasonably required by the company and, if requested, must permit the company's inspection of the EAGLE window or door within a reasonable period of time after the claim is made. If, after investigation, the company determines that the claim is valid, the remedy will be in accordance with the terms and conditions of these Warranties.

The company reserves the right to perform all Warranty work or arrange for another party to perform the Warranty work.

The "original consumer" as stated throughout this Warranty is considered the party that owns or is the permanent resident of the building. This does not include builders unless they occupy the residence for more than one year.

The applicable Warranty period will be extended by the period of performance of any Warranty work, but thereafter the remaining original Warranty period will continue in effect and be applicable to the Warranty work performed under the terms and conditions of these Warranties. The company reserves the right to discontinue or modify part or all of any of its EAGLE windows or doors. If an EAGLE window or door the same as the EAGLE window or door or any part covered by these Warranties is not available at the time of repair or replacement, the company reserves the right to substitute a similar EAGLE window or door or part selected by the company of equivalent value or to refund the original purchase price of the defective EAGLE window or door.



